

Kit 1222

AUDI A8, 4-dr Sedan, 95-00, 01-02 / *96-03

AUDI S8, 4-dr Sedan, 95-00, 01-02 / *01-03

*North America

480R
754

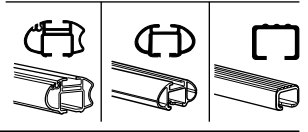
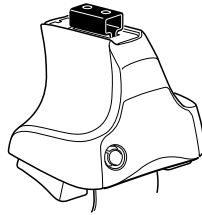

480

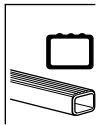
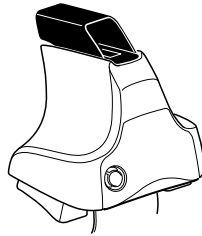

750

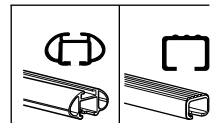
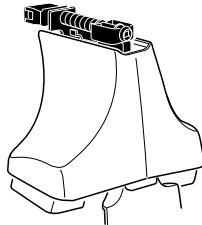

Kit

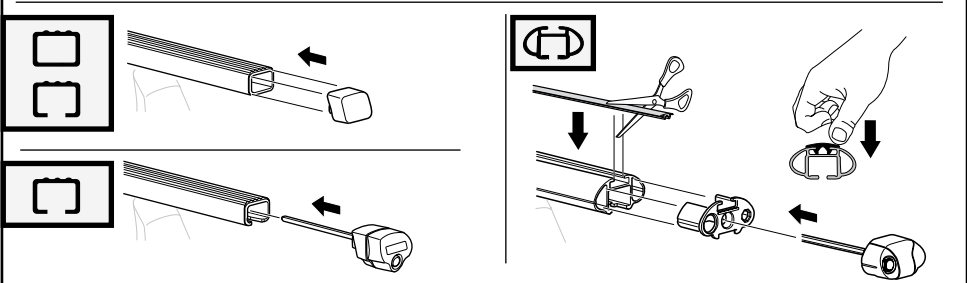
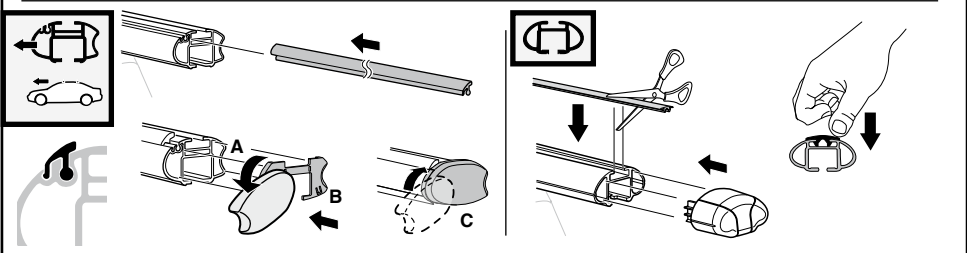
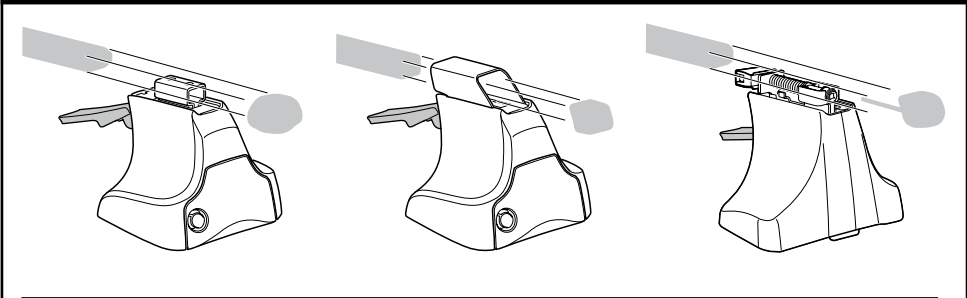
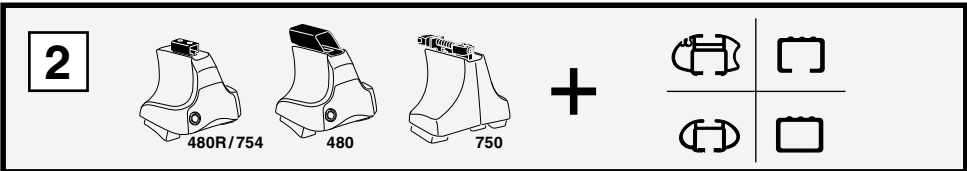
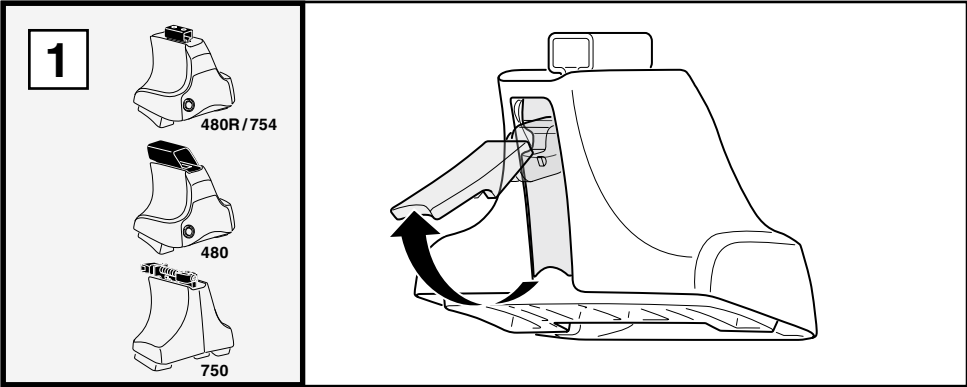

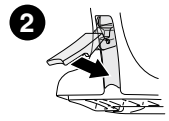
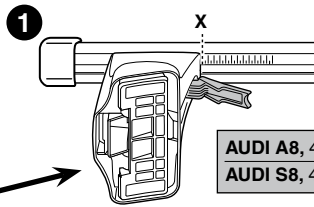
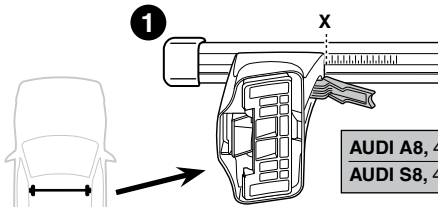
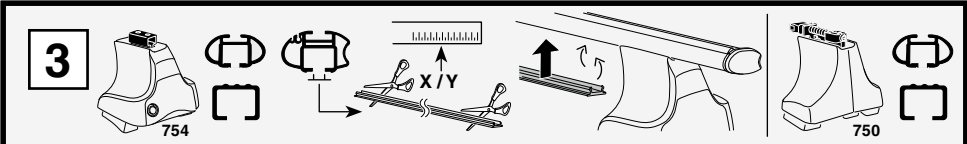

	X
AUDI A8, 4-dr Sedan, 95-00, 01-02 / *96-03	36
AUDI S8, 4-dr Sedan, 95-00, 01-02 / *01-03	36

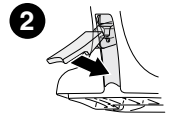
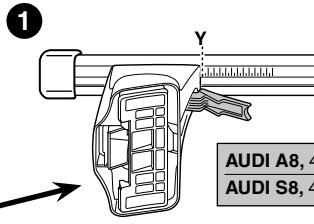
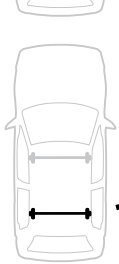

	Y
AUDI A8, 4-dr Sedan, 95-00, 01-02 / *96-03	38
AUDI S8, 4-dr Sedan, 95-00, 01-02 / *01-03	38

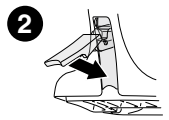
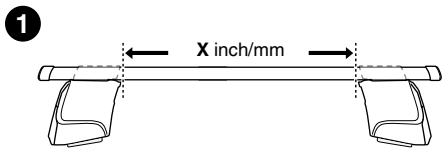
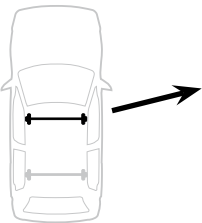
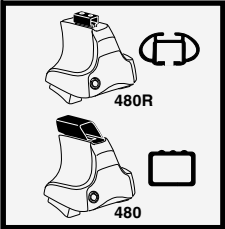

	X inch	X mm
AUDI A8, 4-dr Sedan, 95-00, 01-02 / *96-03	39 ³ / ₄ "	1011 mm
AUDI S8, 4-dr Sedan, 95-00, 01-02 / *01-03	39 ³ / ₄ "	1011 mm

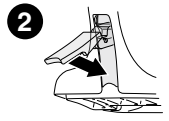
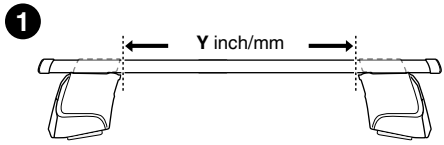
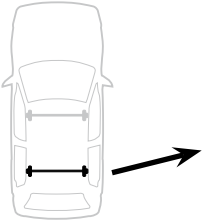

	Y inch	Y mm
AUDI A8, 4-dr Sedan, 95-00, 01-02 / *96-03	40 ⁵ / ₈ "	1031 mm
AUDI S8, 4-dr Sedan, 95-00, 01-02 / *01-03	40 ⁵ / ₈ "	1031 mm

4

AUDI A8, 4-dr Sedan, 95-00, 01-02 / *96-03

AUDI S8, 4-dr Sedan, 95-00, 01-02 / *01-03

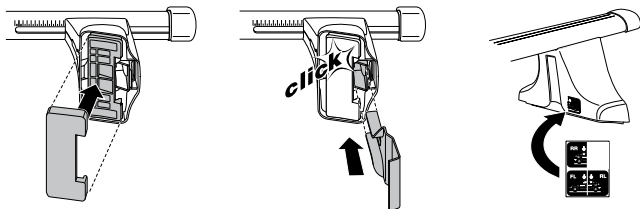
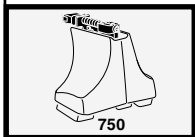
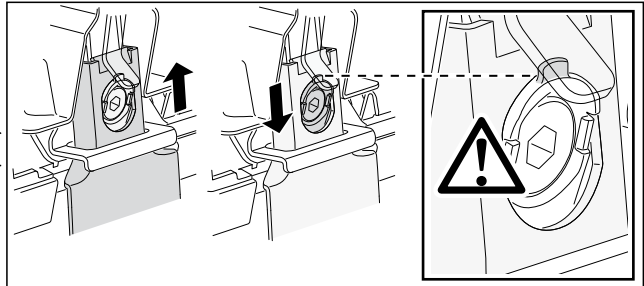
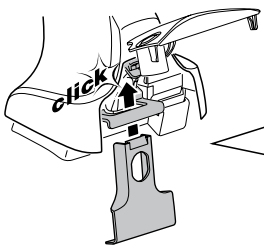
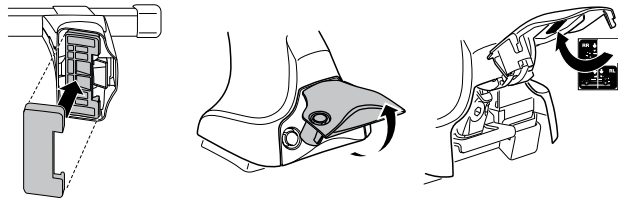
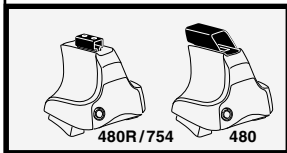
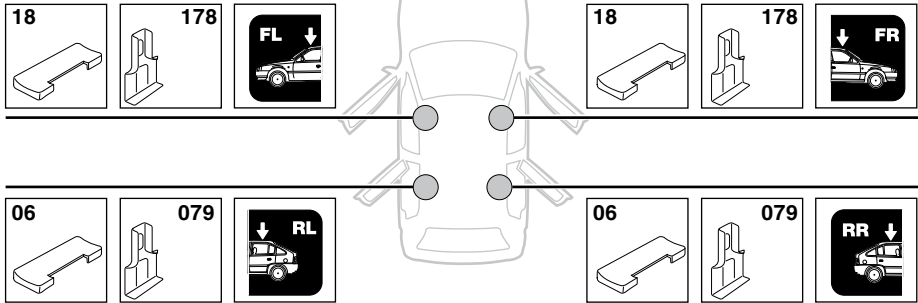

5

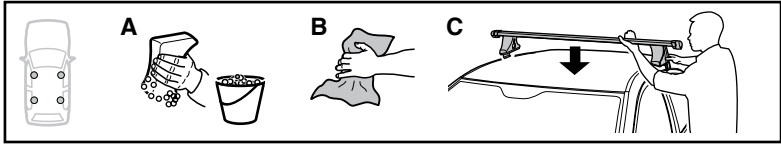

	X mm	Y mm	X inch	Y inch
AUDI A8 , 4-dr Sedan, 95-00, 01-02 / *96-03	255 mm	715 mm	10"	28 1/8"
AUDI S8 , 4-dr Sedan, 95-00, 01-02 / *01-03	255 mm	715 mm	10"	28 1/8"

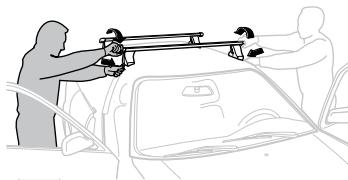
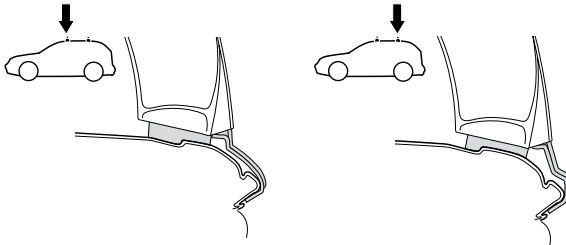
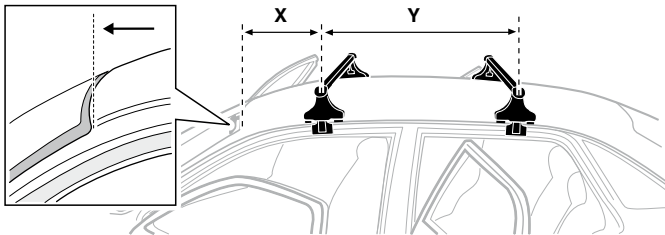

GB/US Tighten alternately

D Die Schrauben abwechselnd anziehen

F Serrer alternativement chaque côté

NL Afwisselend aan de linker- en de rechterkant aandraaien

I Alternare il serraggio delle viti

E Apretar alternativamente

PT Aperte alternadamente

S Dra åt växelvis

FIN Kierrä vuorotellen

EST Pinguldage vaheldumisi

LAT Pielieciet pamišus

LIT Užsukinėkite pakaitomis

PL Śruby dokręcaj naprzemiennie

RU Затягивайте попеременно

CZ Pokręťta bagażníka dokręcaj dokręcaj naprzemiennie.

SK Doťahujte striedavo

SLO Privijajte izmenično.

HR Naizmjenično zategnite

HU Egymástól függetlenül szorítandó

GR Σφίγγετε εναλλάξ

TR Dönüşümlü sıkın

中文 交替拧紧

한국어 번갈아 가며 조이십시오.

日本語 交互に締め付けてください。

ไทย ชั้้นโน้แบบสลับ

6



480R/754



480

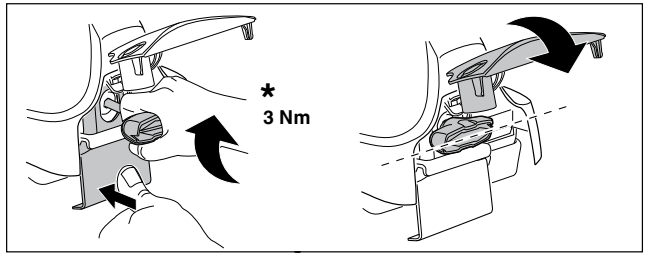
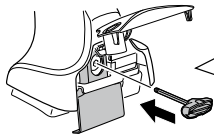

*
3 Nm

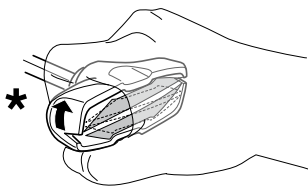

*

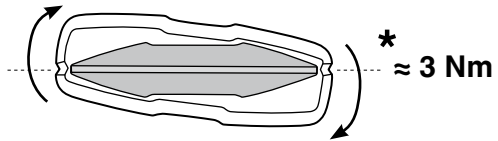

*
≈ 3 Nm

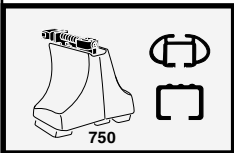
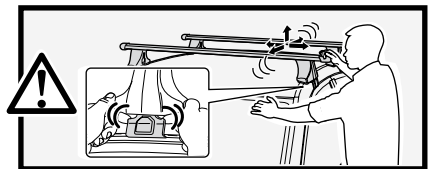

750

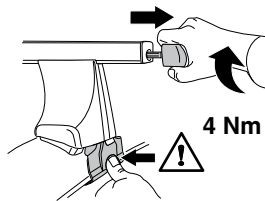

4 Nm

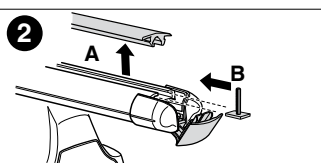
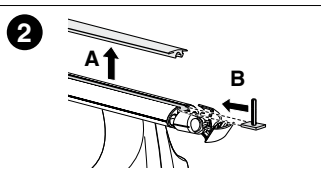
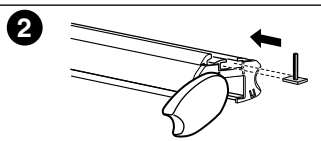
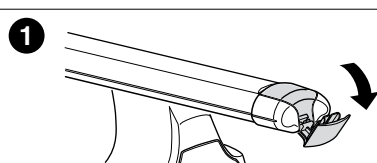
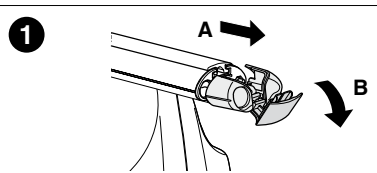
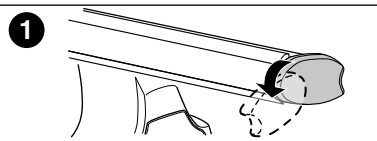
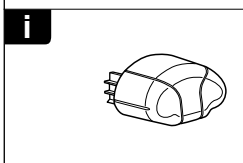
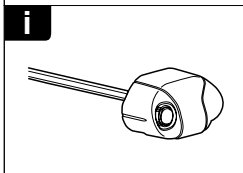
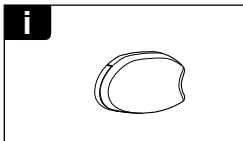
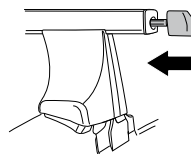

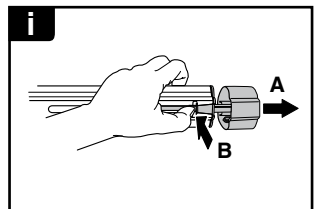
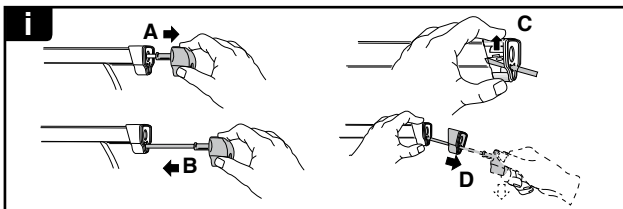
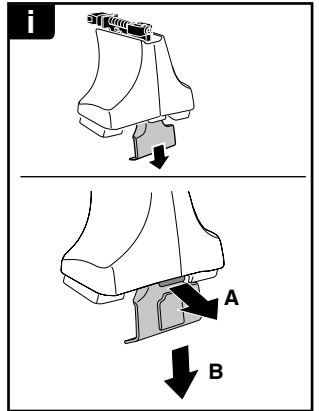
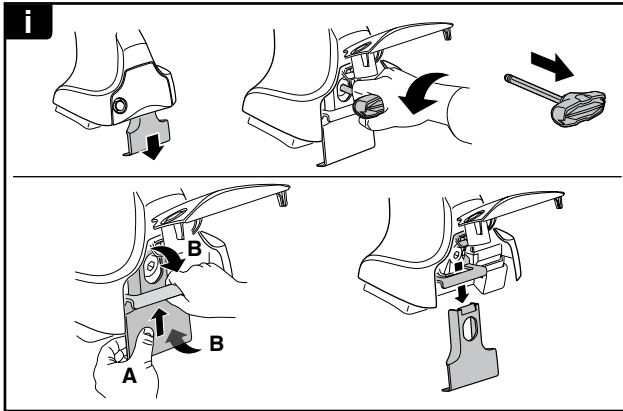
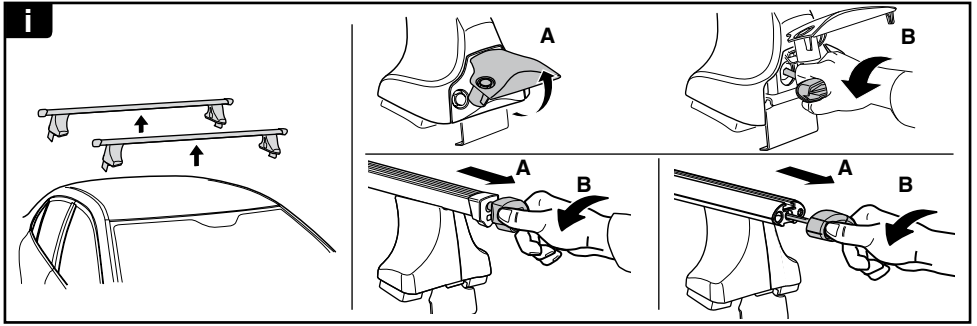

THULE
SWEDEN
**ONE
KEY
SYSTEM**

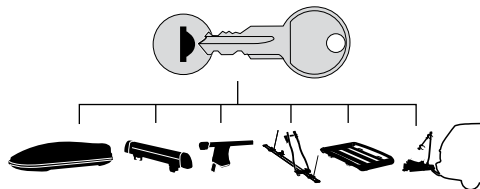

		544	(x4)
		596	(x6)
		588	(x8)
NA		510	(x10)
EUR		452	(x12)
ASIA			

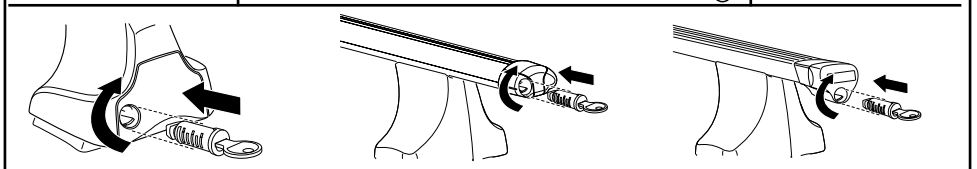

WW ▶ Thule Sweden AB, Box 69, 330 33 Hillerstorp, SWEDEN
NA ▶ Thule Inc., 42 Silvermine Road, Seymour, Connecticut 06483, USA

info@thule.com
customer.service@thule.com

www.thule.com