

1

Kit 145088

RENAULT Grand Scénic III, 5-dr MPV, 09-16

RENAULT Scénic III, 5-dr MPV, 09-16



ISO 11154-E

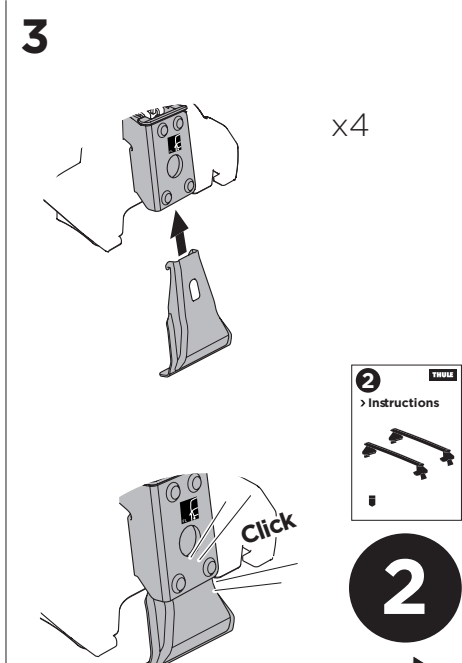
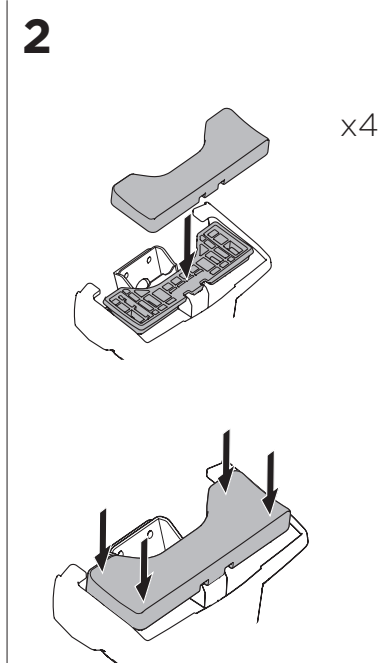
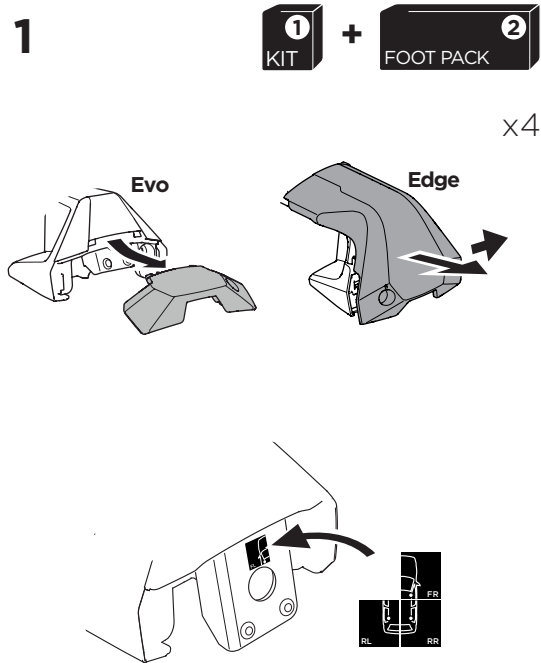
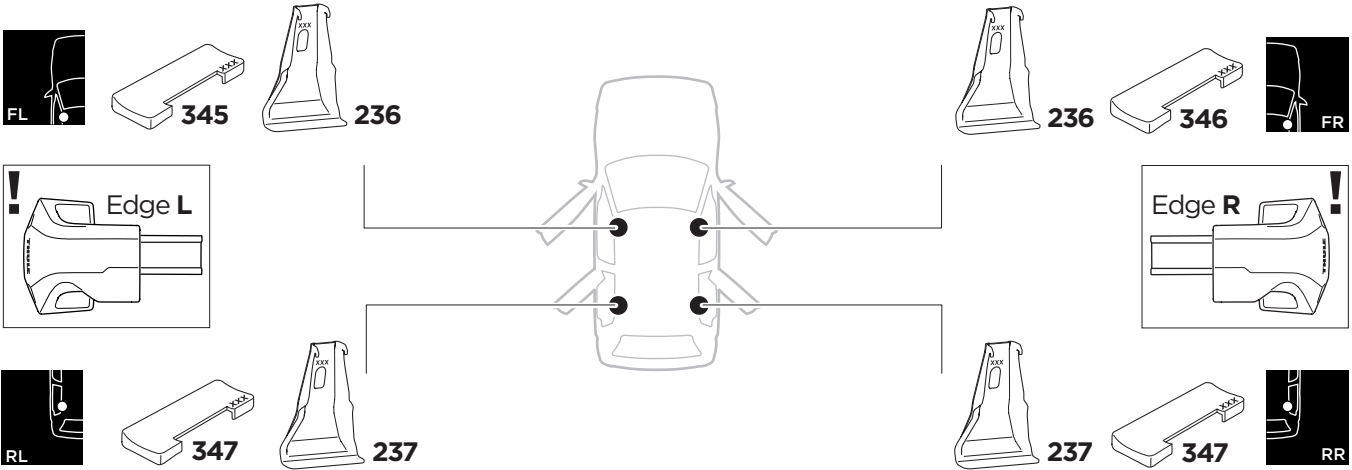
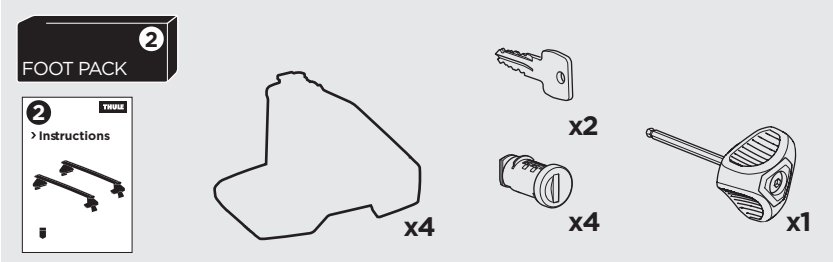
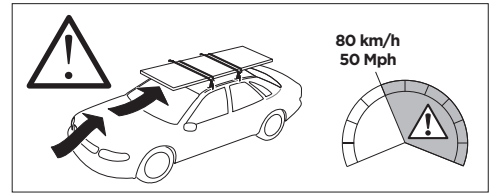
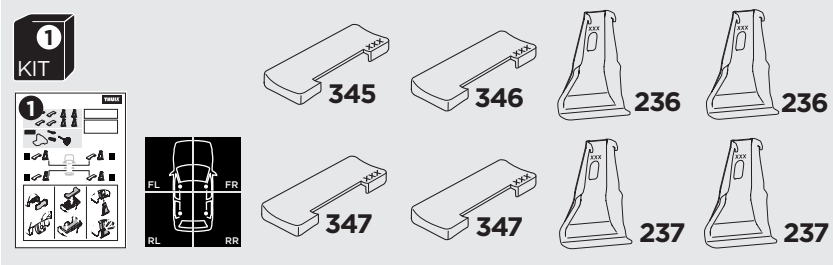



THULE WingBar Evo THULE WingBar Edge THULE WingBar THULE SquareBar	Evo X (scale)	Edge X (scale)
RENAULT Grand Scénic III, 5-dr MPV, 09-16	43	K
RENAULT Scénic III, 5-dr MPV, 09-16	43	K

THULE ProBar THULE SlideBar	X (mm/inch)
RENAULT Grand Scénic III, 5-dr MPV, 09-16	1081 mm / 42 1/2"
RENAULT Scénic III, 5-dr MPV, 09-16	1081 mm / 42 1/2"

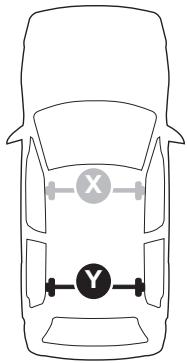

THULE WingBar Evo THULE WingBar Edge THULE WingBar THULE SquareBar	Evo Y (scale)	Edge Y (scale)
RENAULT Grand Scénic III, 5-dr MPV, 09-16	42,5	L
RENAULT Scénic III, 5-dr MPV, 09-16	42,5	L

THULE ProBar THULE SlideBar	Y (mm/inch)
RENAULT Grand Scénic III, 5-dr MPV, 09-16	1076 mm / 42 3/8"
RENAULT Scénic III, 5-dr MPV, 09-16	1076 mm / 42 3/8"

	W (mm/inch)	Z (mm/inch)
RENAULT Grand Scénic III, 5-dr MPV, 09-16	725 mm / 28 1/2"	260 mm / 10 1/4"
RENAULT Scénic III, 5-dr MPV, 09-16	725 mm / 28 1/2"	260 mm / 10 1/4"

