

# ➤ Instructions

## Thule Evo Raised Rail 7104

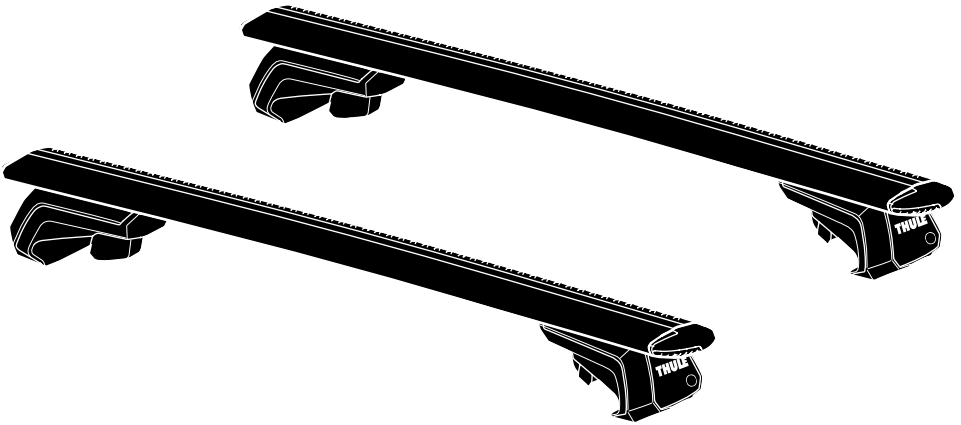

**EN** Roof mounted load carrier  
**DE** Lastenträger zur Dachmontage  
**FR** Barre de toit  
**NL** Dakdrager  
**IT** Barra portatutto da installare sul tetto  
**ES** Portaequipajes de techo  
**PT** Barra para montagem no tejadilho  
**SV** Takmonterad lasthållare  
**DK** Tagmonteret lastholder  
**NO** Takmontert lasteholder  
**FI** Katolle asennettava teline  
**ET** Katusele paigaldatav katuseraam  
**LV** Uz jumta uzstādāms kravas turētājs  
**LT** Ant stogo tvirtinamas krovinių laikiklis  
**PL** Uchwyt na bagażnik bazowy montowany na dachu  
**RU** Багажник на крышу  
**UK** Багажник для даху  
**BG** Багажник, монтиран върху покрива  
**CS** Nosič pro montáž na střechu  
**SK** Strešný nosič  
**SL** Nosilec za strešni prtljajnik

**HR/BIH** Krovni nosač tereta  
**RO** Suport încărcătură montat pe acoperiș  
**HU** Tetőre szerelhető csomagszállító  
**EL** Σχήμα οροφής για μεταφορά φορτίου  
**TR** Araç üstüne bağlanan yük taşıyıcı

**HE** מנשא מטען על הגג  
**AR** حامل نقل مثبت على السقف

**ZH** 顶置行李架  
**JA** ルーフマウント型ロードキャリア  
**KO** 루프 장착 화물 캐리어  
**TH** โครงยึดของบรรทุกแบบติดตั้งบนหลังคา

**CITY CRASH**  
 Complies with ISO norm

ISO 11154-E

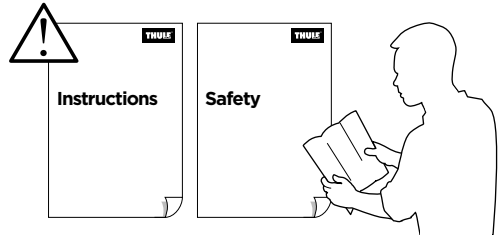

## >Mounting Tutorial

Thule Evo Raised Rail

**THULE**  
SWEDEN



thule.com

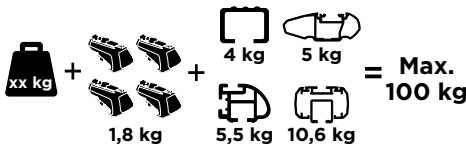
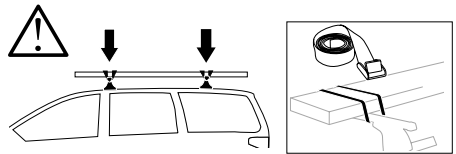
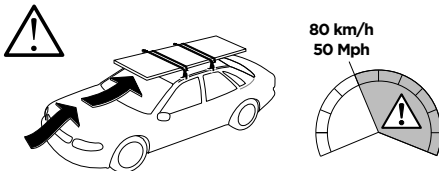

**2**  
FOOT PACK

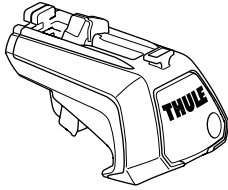

x4



x4



x2

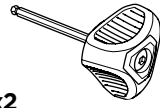

4 Nm

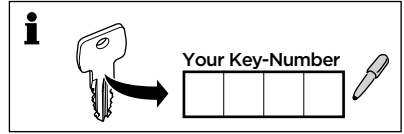

**3**  
BAR

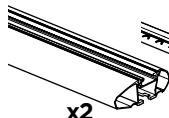

x2

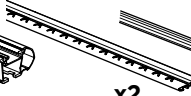

x2



x2



x2



x2

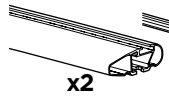

x2



x2



x2

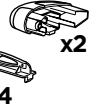

x2



x2

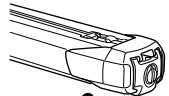

x2



x2



x2



x1



x2



x1

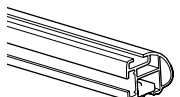

x2

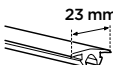

23 mm

x2

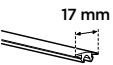

17 mm

x2



x4



x4



x1



x2



x2

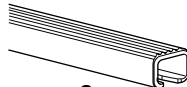

x2



x4

1

A

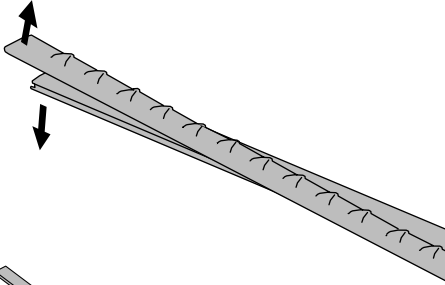

B

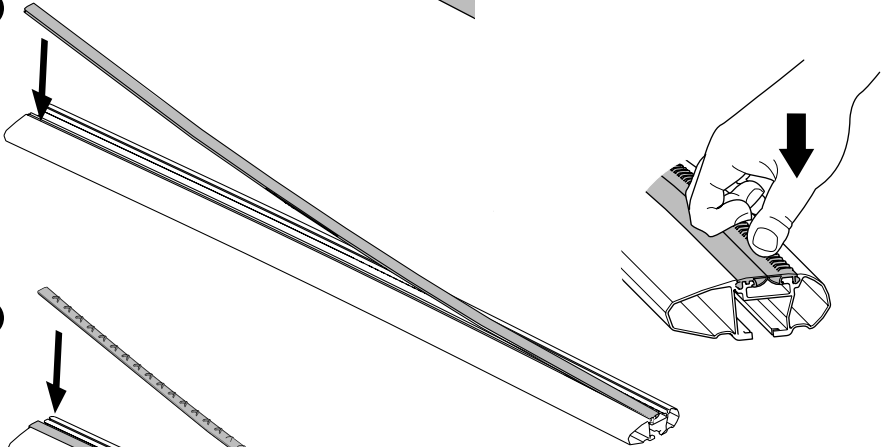

C

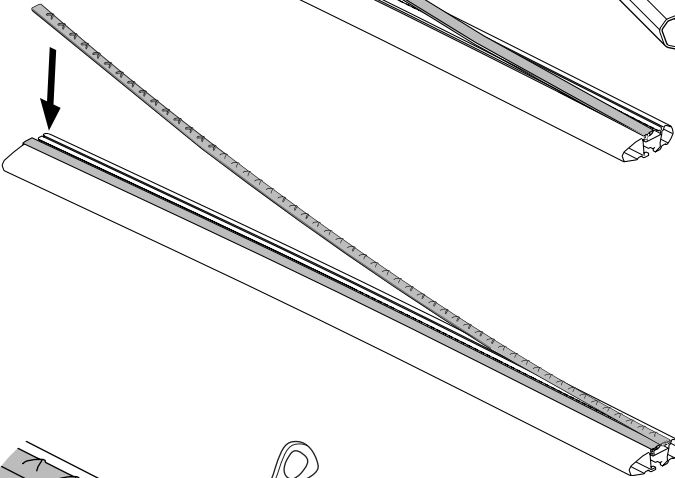

D

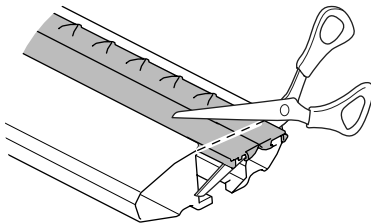

x2

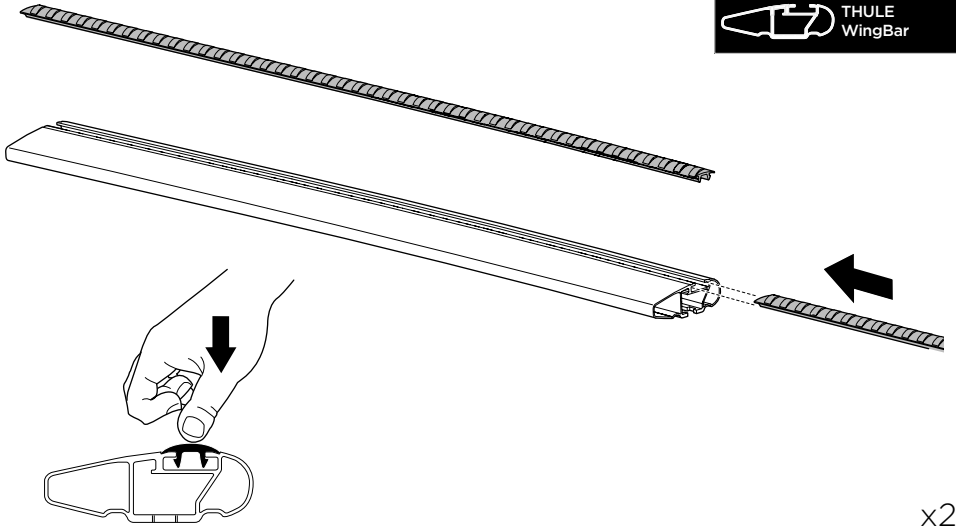

x2

2



A



B



C

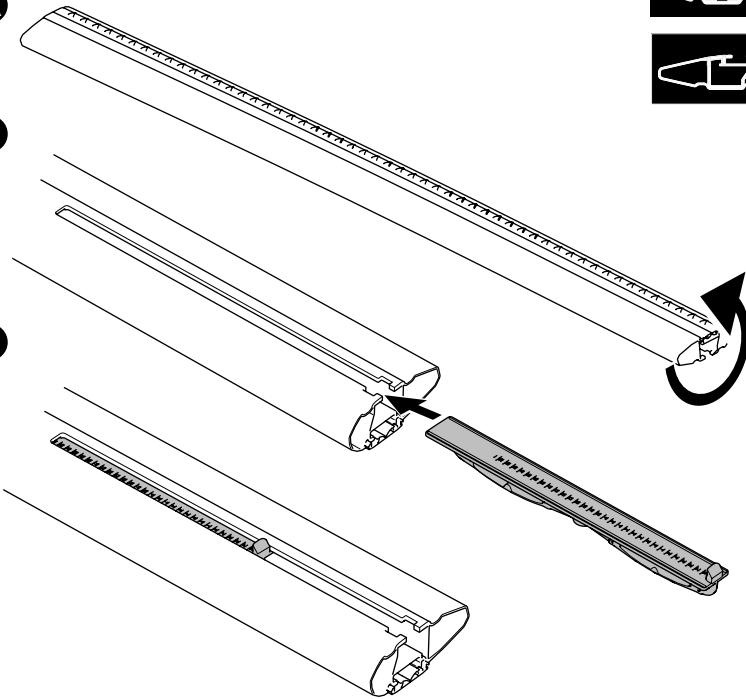

x4

3

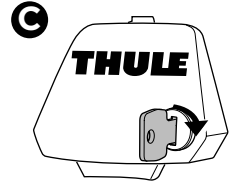
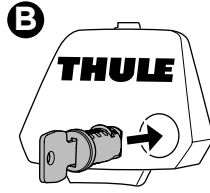
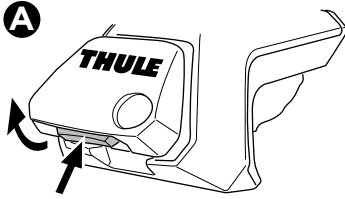

x4

4

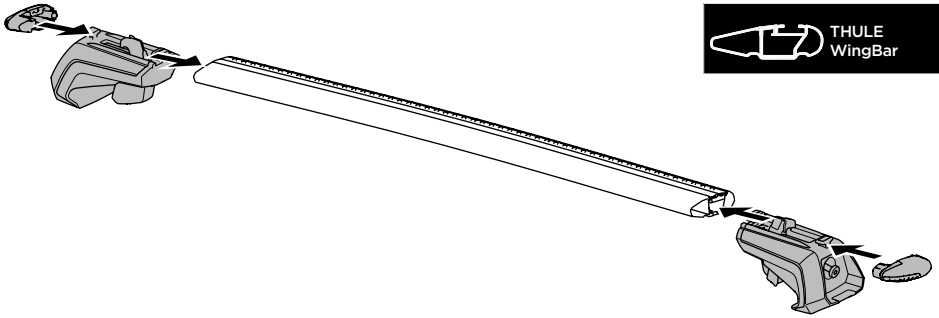

x2

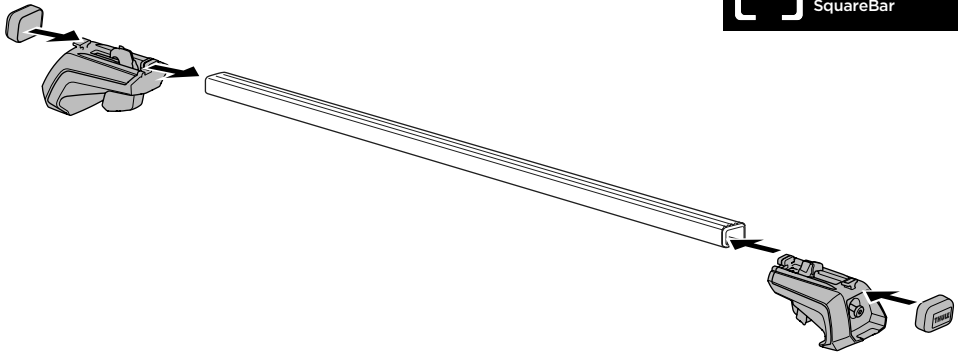

x2

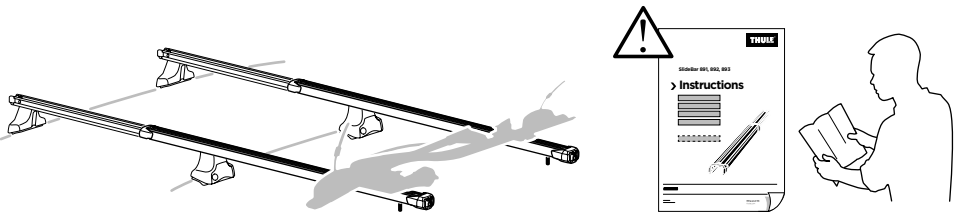
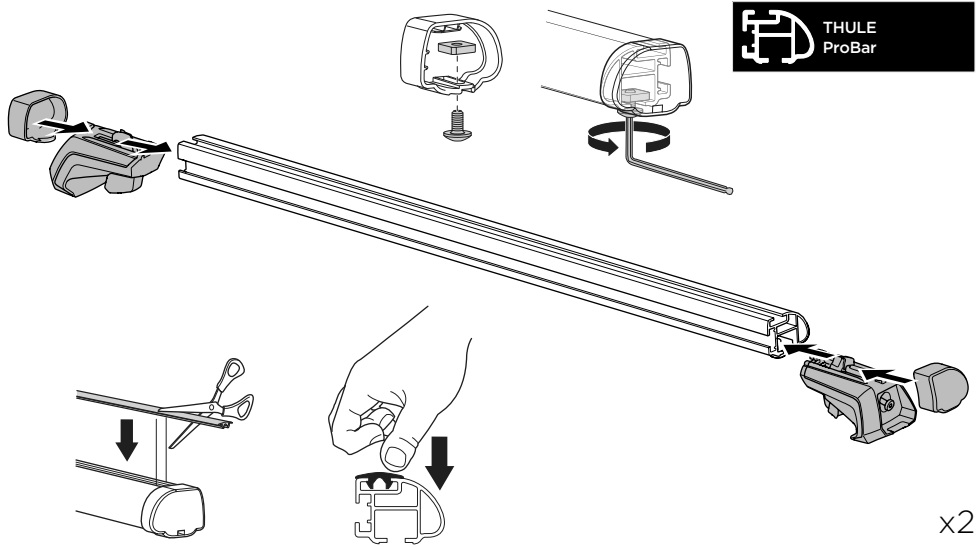

5

A

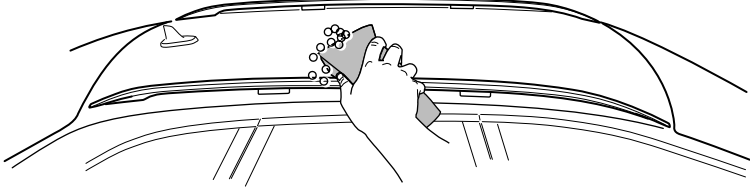

B

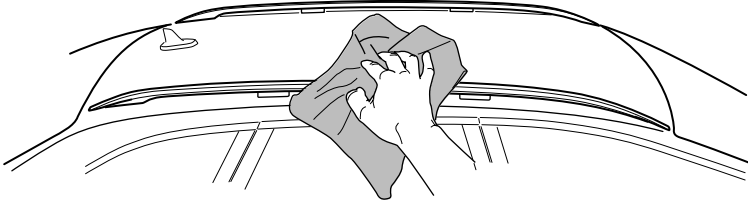

6

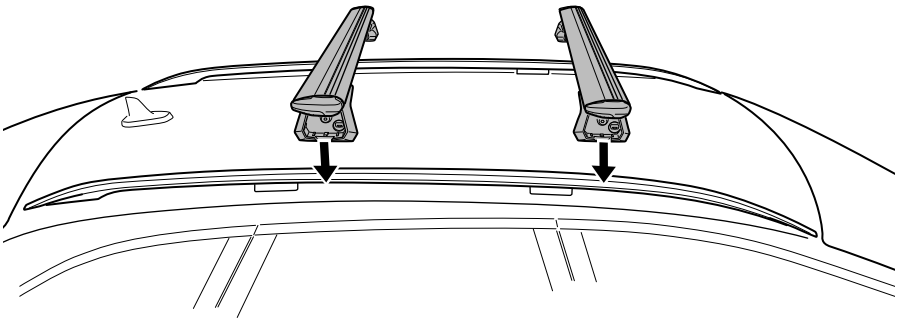
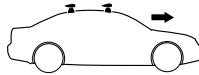



7

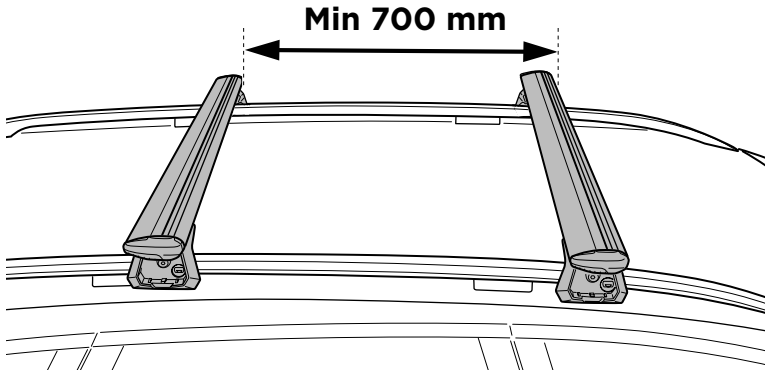

8

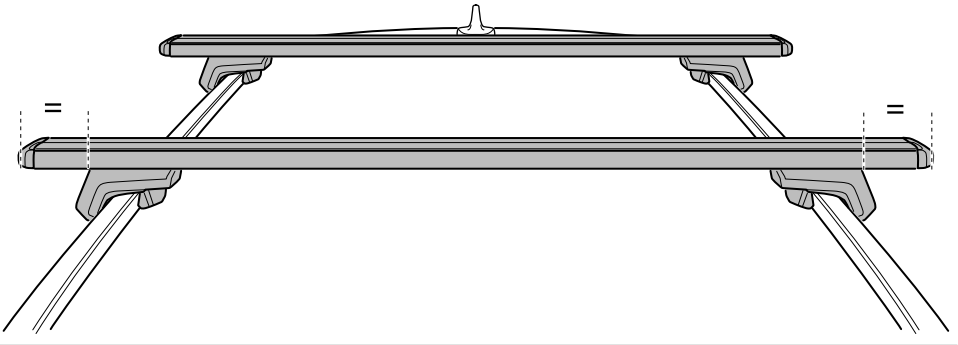

9

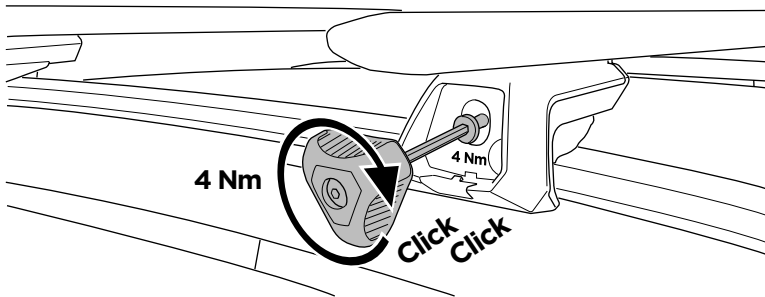

x4

10

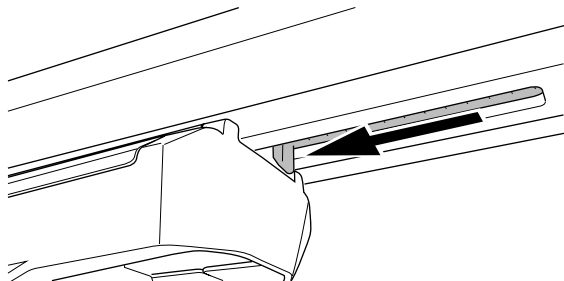

x4

11

A

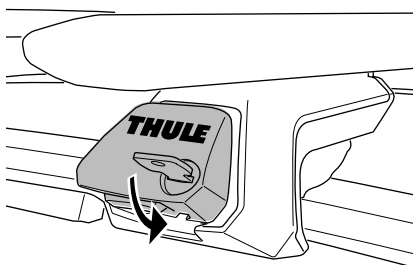

B

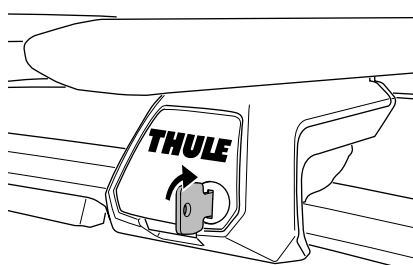

x4

12

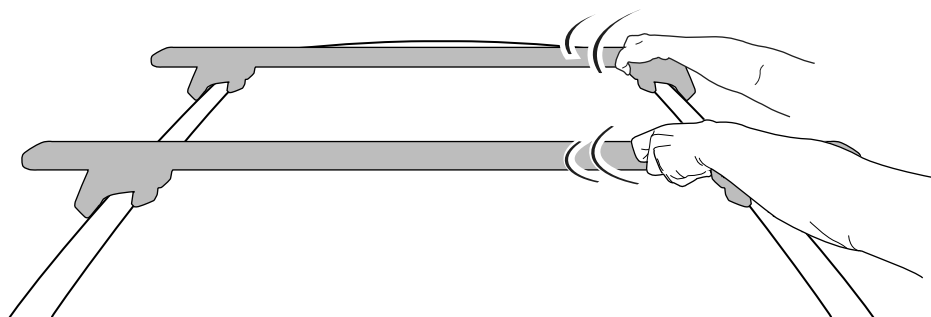

13

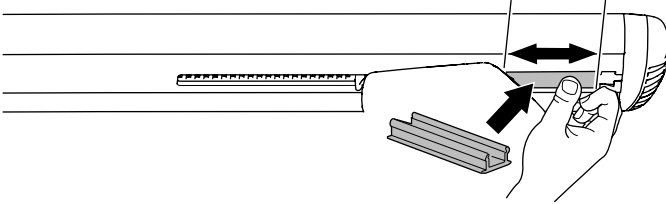
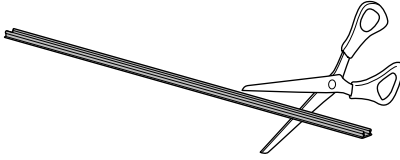

x4

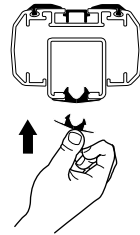
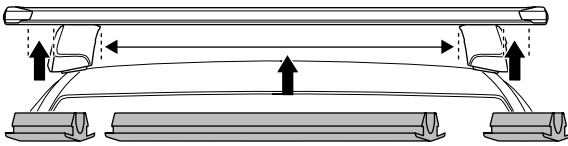
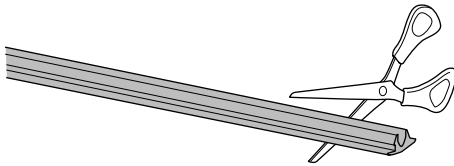

x2

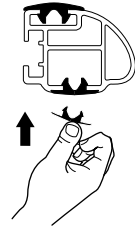
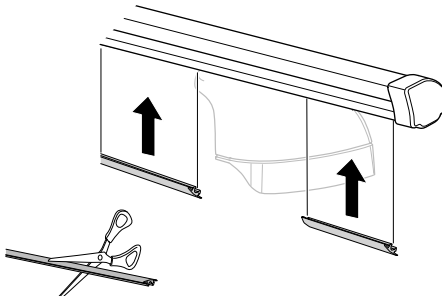
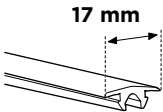

x2

**i**

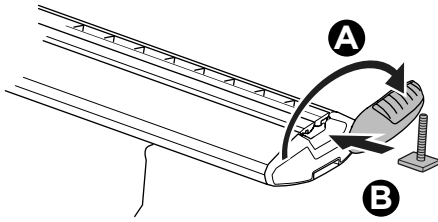

 THULE  
WingBar Evo

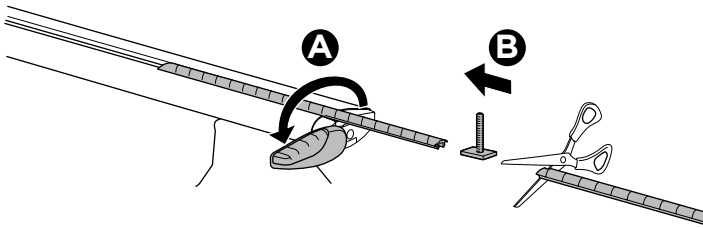
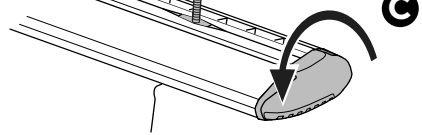

 THULE  
WingBar

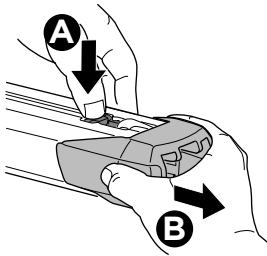

 THULE  
SlideBar

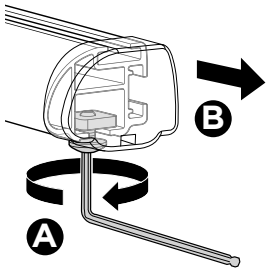
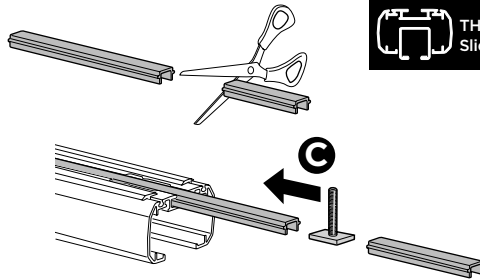

 THULE  
ProBar

