

BARRE DA TETTO
ROOF BARS
BARRAS DE TECHO
BARRES DE TOIT
DACHTRÄGER

MENABO
free time on the move

OE

JEEP COMPASS 2016>

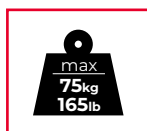
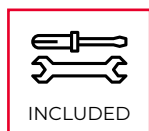



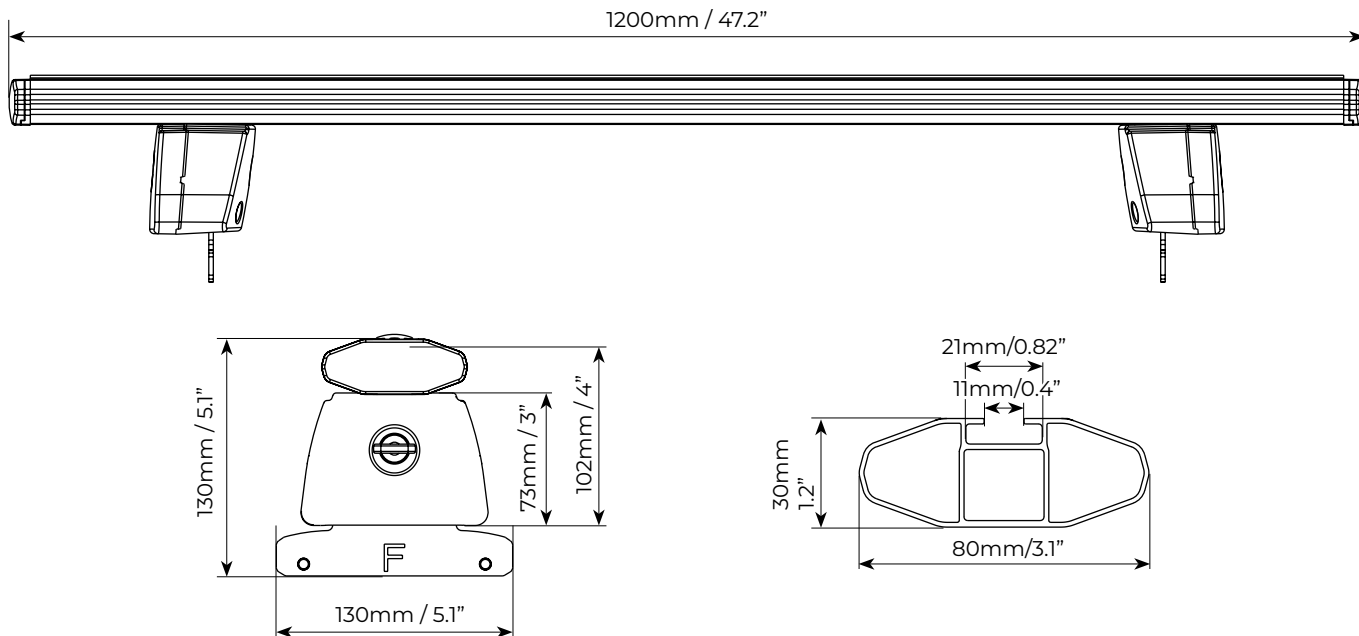

Barre da tetto con profilo in alluminio largo e piatto per una migliore aerodinamicità. Provviste di scanalatura per il montaggio rapido degli accessori tramite viti a "T" e gomma anti-fischio. Dotate di serratura antifurto di serie. Compatibili solo con Jeep Compass (MP/552) 2016>.

Roof bars with wide and flat aluminium profile for improved aerodynamics. Provided with groove for quick mounting of accessories by means of "T" screws. Equipped with anti-theft lock as standard. Compatible only with Jeep Compass (MP/552) 2016>.

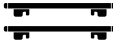



OE Jeep Compass 2016>	Art.000139900000
 Peso prodotto Product weight	4kg / 8.8lb
Materiale Material	Alluminio Aluminium
 Portata massima Max load	max 75kg/165lb
 Serratura antifurto Anti-theft lock	✓
 Veicoli compatibili Compatible vehicles	Jeep Compass (MP/552) 2016>

F.lli Menabò s.r.l.

Via 8 Marzo 3,
 42025 Cavriago (RE), Italy
 customercare@flli-menabo.it
 www.menabocaraccessories.com

Product logistics

